

NOTE: Part number of this accessory may not be the same as the part number shown.

Part Number: PTR03-12190

Kit Contents

Item #	Qty.	Service Part #	Description
1	1	PTR03-12190-AA	TRD Upper air box
2	1	PTR03-1C161	TRD Air Filter
	1	PTR03-12190-AB	Coupler Kit
3	2		#40 Hose Clamp
4	1		Coupler
5	1		Zip Tie

Additional Items Required for Installation

Item #	Quantity Req'd.	Description
None		

Conflicts

NA

Recommended Tools

Safety Tools	Notes
Vehicle Protection	Blankets or Fender Covers
Special Tools	Notes
None Required	
Installation Tools	Notes
Nut Driver or Socket	8mm or 5/16"
10mm Socket	
Drive Ratchet	
Drive Extension	
Pliers	
Torque Wrench	In.lb. (0-120 in.lb.)
Phillips Screw Driver	#3
Special Chemicals	Notes
None	

General Applicability

--

Torque Specifications

Hardware Type	SAE Torque in.lb	Metric Torque Nm
Hose Clamp	30 ± 5	3.4 ± 0.6
Battery Terminal	48 ± 5	5.4 ± 0.6

Vehicle Service Parts (may be required for reassembly)

Item #	Quantity Req'd.	Description

Legend

 **STOP:** Damage to the vehicle may occur. Do not proceed until process has been complied with.

 **OPERATOR SAFETY:** Use caution to avoid risk of injury.

 **CAUTION:** A process that must be carefully observed in order to reduce the risk of damage to the accessory/vehicle and to ensure a quality installation.

 **TOOLS & EQUIPMENT:** Used in Figures calls out the specific tools and equipment recommended for this process.

 **REVISION MARK:** This mark highlights a change in installation with respect to previous issue.

 **SAFETY TORQUE:** This mark indicates that torque is related to safety.

Emissions Compliance Information:

A new process has been implemented. The Emissions Label is No Longer included in the Performance Air Intake Kit.

If your state requires an Emissions Compliance Label, one may be ordered.

This TRD Performance Air Intake Kit has received 50-State Emissions Compliance via the California Air Resources Board (CARB). Not all states require the Emissions Compliance Label but TRD does recommend ordering one. To receive the proper Emissions Compliance Label for this TRD Performance Air Intake Kit, please order part number **PT965-12190-0E**. Proof of ownership may be required.

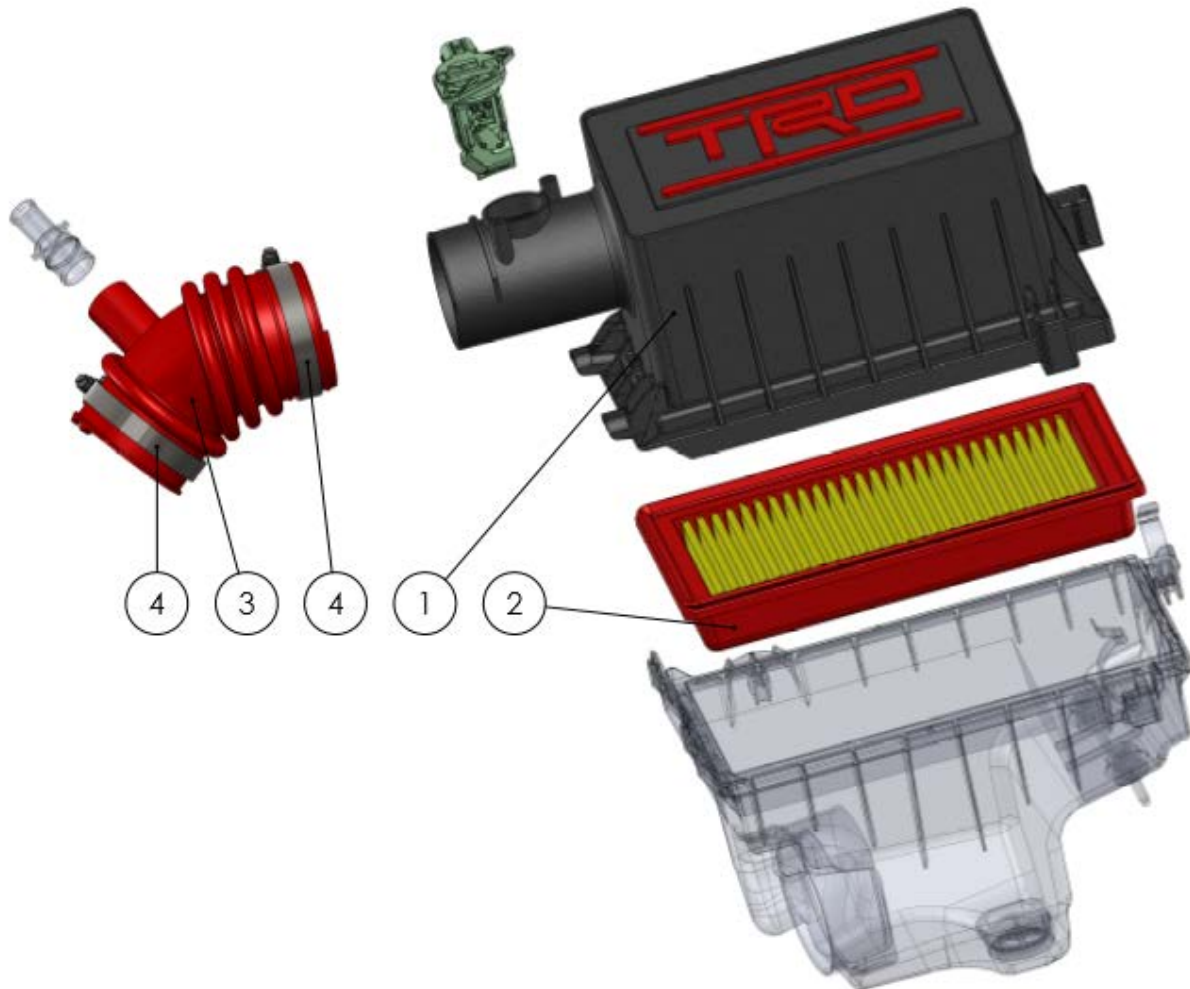

Care must be taken when installing this accessory to ensure damage does not occur to the vehicle. The installation of this accessory should follow approved guidelines to ensure a quality installation.

These guidelines can be found in the "Accessory Installation Practices" document.

This document covers such items as:

- Vehicle Protection (use of covers and blankets, cleaning chemicals, etc.).
- Safety (eye protection, rechecking torque procedure, etc.).
- Vehicle Disassembly/Reassembly (panel removal, part storage, etc.).
- Electrical Component Disassembly/Reassembly (battery disconnection, connector removal, etc.).

Please see your Toyota dealer for a copy of this document.

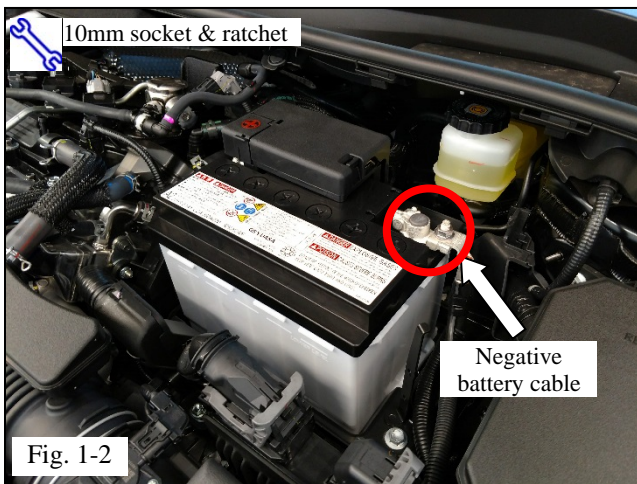
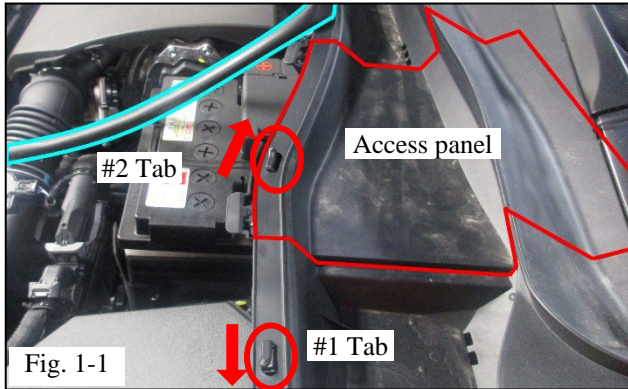

1. Prepare for the Installation

- STOP** (a) Confirm the Electric Parking Brake is engaged.
- (b) Open hood.
- STOP** (c) Protect the fender before starting.
- (d) Locate the hood weather-strip on the cowl trim (outlined in blue, Fig. 1-1).
- (e) Pull the weather-strip outboard and lift to remove it from Tab #1 (Fig. 1-1).
- (f) Push the weather-strip inboard and lift to remove it from Tab #2 (Fig. 1-1).
- (g) Lay the weather-strip away from the cowl (Fig. 1-1).

NOTE: Tab #1 and Tab #2 point in opposite directions. Take care not to damage the weather-strip during removal.



- (h) Disengage the Access Panel front clips (x2), then lift the panel up and away from the windshield edge to disengage the rear clips. Set the panel aside.
- (i) Remove the negative battery cable (Fig. 1-2).



CAUTION: Do not touch the positive terminal with any tool when removing cable.



2. Remove Factory Components

- (j) Unplug MAF sensor and unclip the MAF sensor wiring harness from the OEM air box lid. (Fig. 2-1)



- (k) Disconnect the crank case vent hose from the OEM air intake bellows, by pinching the spring clamp and pulling off. (Fig. 2-2)

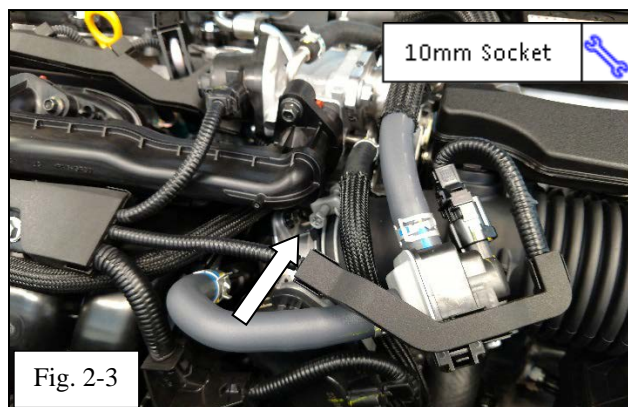

- (l) Loosen the OEM hose clamp at the throttle body. (Fig. 2-3)

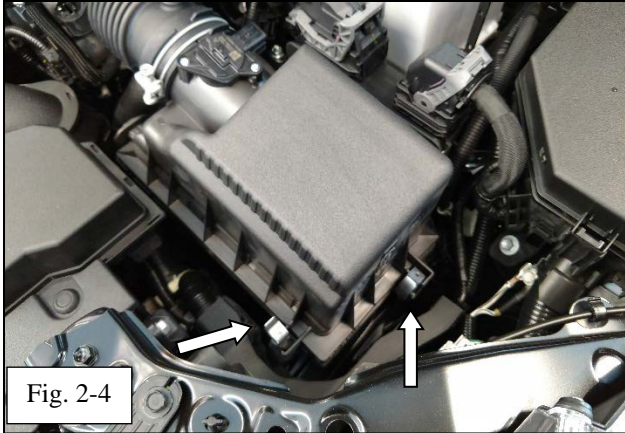

(m) Unclip the two air box clips. (Fig. 2-4)



(n) Lift and remove the upper air box and coupler as an assembly. (Fig. 2-6)

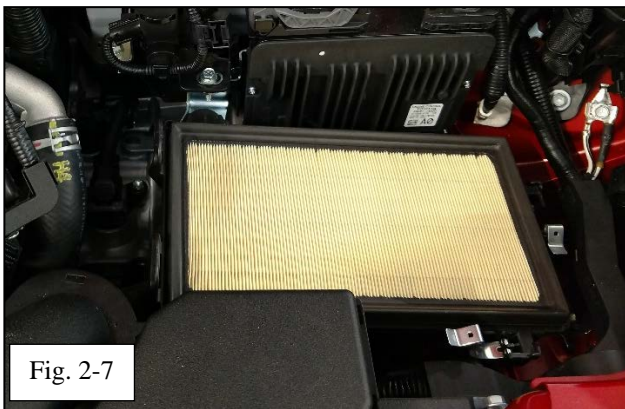

(o) Remove the OEM air filter. (Fig. 2-7)

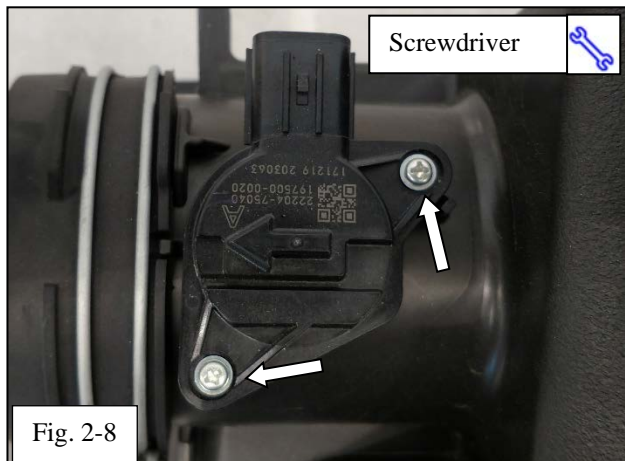

(p) On a workbench, remove the MAF sensor from the OEM air box by removing the two screws. (Fig. 2-8)
Keep the screws and MAF sensor for later re-use.

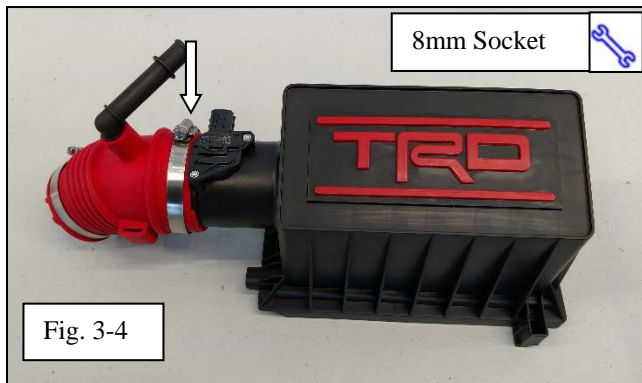
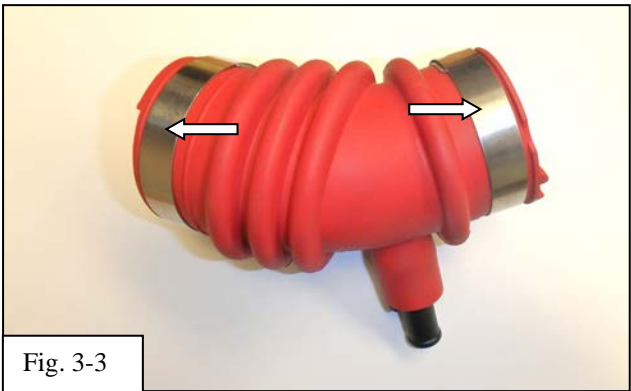
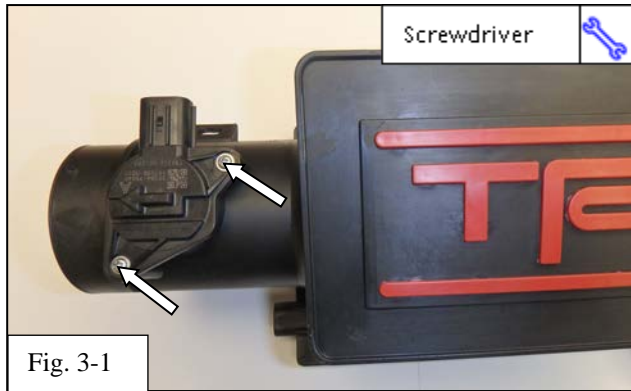

3. Install TRD Air Intake

- (a) On a workbench, install the MAF sensor into the TRD air box. (Fig. 3-1)
 - i Secure using the screws removed in step 2h

- (b) On a workbench, install the plastic PCV connector barb into the TRD coupler (Fig. 3-2)

NOTE: The connector barb may be lubricated with a small amount of soapy water to aid installation.

- (c) On a workbench, install the 2 hose clamps loosely as shown, do not tighten at this point. (Fig. 3-3)

- (d) On a workbench, connect the coupler to the airbox neck; do not tighten at this stage. (Fig. 3-4)



- (e) Install the TRD air filter. Noting proper orientation by matching the square corner of the air filter to the proper corner of the OEM lower air box. (Fig 3-5)



- (f) Install the TRD coupler loosely on the throttle body. (Fig 3-6).

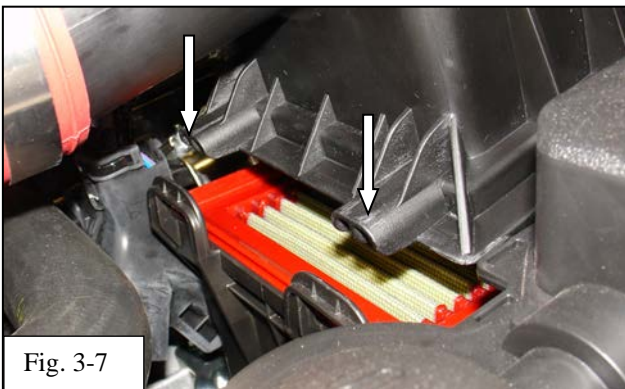

- (g) Guide the inboard mounts of the air box top into the loops on the OEM lower air box. (Fig. 3-7)



-  (h) Insure that the upper airbox is properly seated on the air filter and secure the upper air box with the 2 air box clips (Fig 3-8)

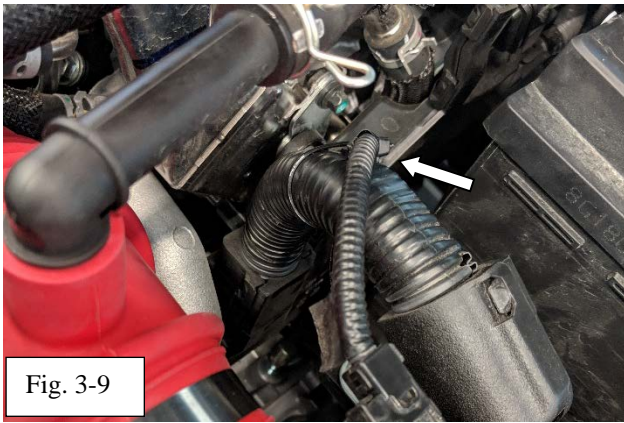

- (i) Route MAF sensor wire behind and over large diameter wire harness. Secure with included zip tie.

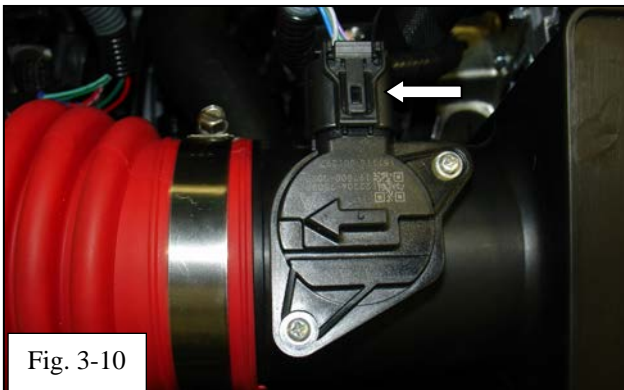

- (j) Plug in the MAF sensor connector and secure the wire harness to the airbox. (Fig 3-10)



- (k) Reconnect the crank case vent hose to the TRD air intake bellows, secure with spring clip. (Fig 3-11)

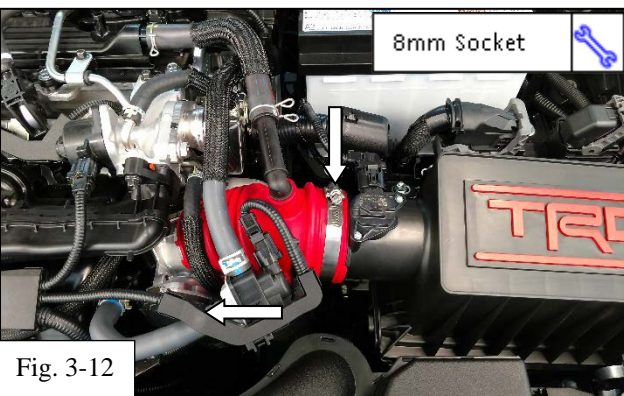

- (l) Tighten coupler hose clamps at the throttle body and air box (Fig 3-12).

 Torque to 30 in.lb ± 5in.lb (3.4Nm ± 0.6Nm)

 Ensure clamp screws do not contact any nearby wiring, hoses or components when tightened.

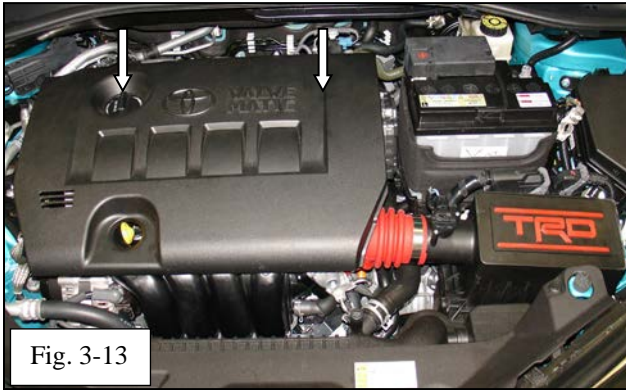



Fig. 3-13

- (m) Re-install engine cover by aligning engine cover grommets above mounting pins and push down to install the engine cover. (Fig. 3-13)



Fig. 3-14

- (n) Do a final check to ensure all wires and hoses are secure. Re-connect the negative battery cable to the negative battery terminal. (Fig 3-14)

 Torque to 48 in.lb \pm 5 in.lb
(5.4 Nm \pm 0.6 Nm)

- (k) Reinstall cowl access panel and reattach weatherstrip removed in step 1.

 Start vehicle and verify no check engine lamp is illuminated.

Care and Maintenance

1. Caring for the Finish on Your TRD Performance Air Intake

- TRD Intake Systems have a natural finish on the couplers and air filter housing.
- To clean your TRD intake system, simply spray with window cleaner and wipe with a soft, clean terry-cloth towel.
- NEVER use harsh chemicals or metal polish on TRD intake systems. Harsh chemicals and metal polishes will permanently damage the finish.
- It is recommended that you service your TRD air filter every 50,000 miles with TRD Filter Service Cleaning Kit, part number PTR43-00088 for optimum performance.

Check:	Look for:
<p><u>Accessory Function Checks</u></p> <p><input type="checkbox"/> Start the vehicle.</p> <p><input type="checkbox"/> If after you start the vehicle, or while driving, you encounter a Malfunction Indicator Lamp (MIL), check the following.</p> <p><input type="checkbox"/> Over-oiled Air Filter</p>	<ul style="list-style-type: none">○ Full engagement of MAF sensor connector.○ Tightness of all clamps.○ Correctly installed valve cover breather hose.○ Over-oiled air filter. ○ Clean the air filter as indicated in the TRD filter cleaning kit and apply the proper amount of oil.○ Replacement (non-warrantable) of the MAF sensor may be required.
<p><u>Vehicle Function Checks</u></p> <p><input type="checkbox"/> Start the vehicle</p> <p><input type="checkbox"/> If the lamp will not go off even after checking and/or repairing any of the above.</p>	<ul style="list-style-type: none">○ Contact your Toyota dealer as soon as possible.